

BATHROOM
Targa Floor-Mounted Tub Filler
w/Deck-Mounted Handshower &
Diverter
G-3653-C14B

GRAFF[®]



Information

- Floor-mount installation
- Aerated Flow Rate ~9 gpm @45 psi
- 9-7/8" spout reach
- 33-1/2" - 36-5/8" ~spout height
- Optional in-line pressure balancing valve
- Handles are required to install rough

G-3653

TARGA Series

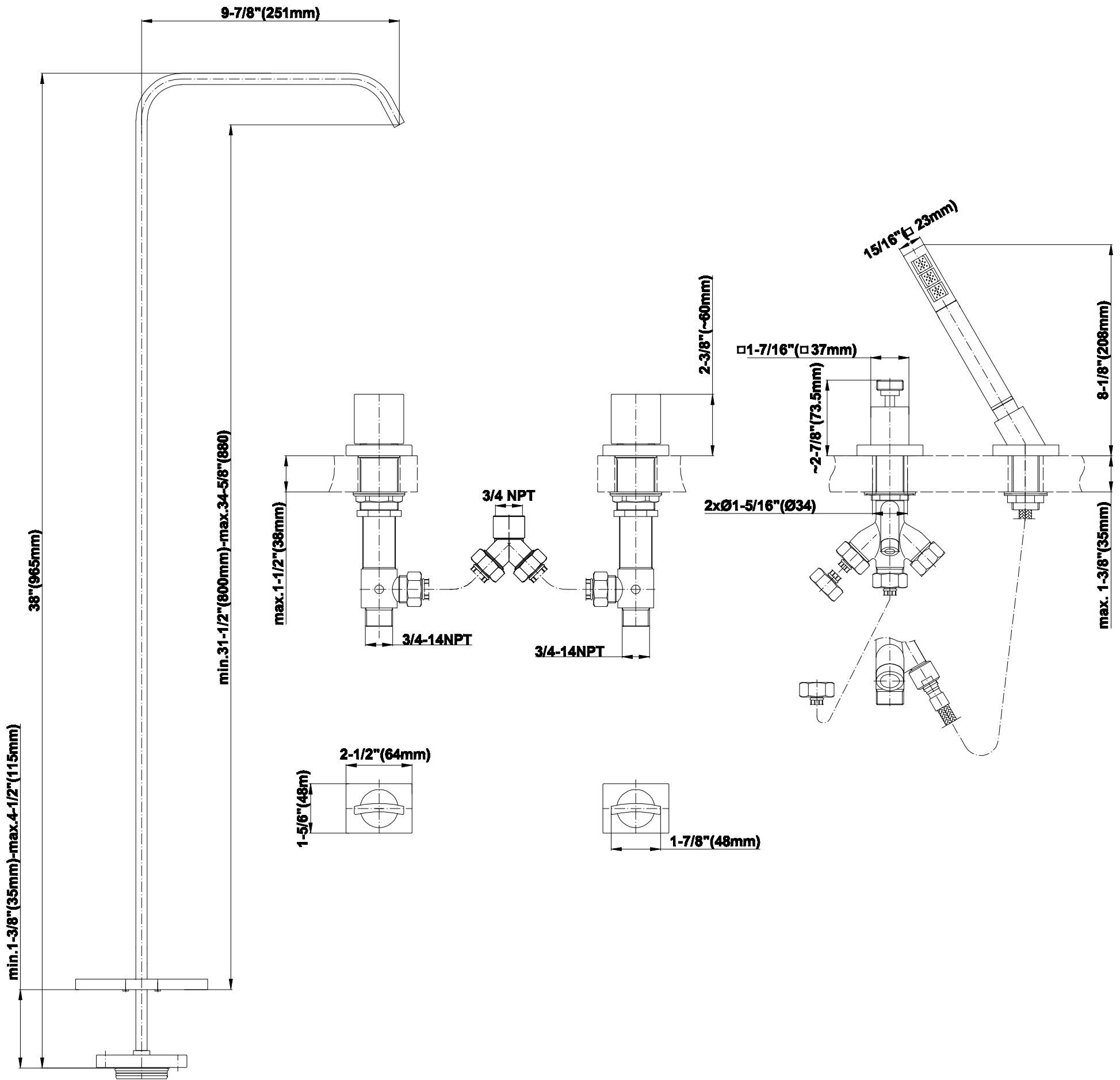

BATHROOM
Sade/Targa/Luna Tub Handle Set -
Deck-Mounted
C14B-BS

GRAFF®



Finishes



24K Gold



24K Brushed
Gold



Architectural
Black™



Brushed
Nickel



Matte Black



Polished
Chrome



Polished
Nickel



Steelnox®
(Satin Nickel)



Architectural
White

C14B-BS

TARGA, SADE, LUNA Series

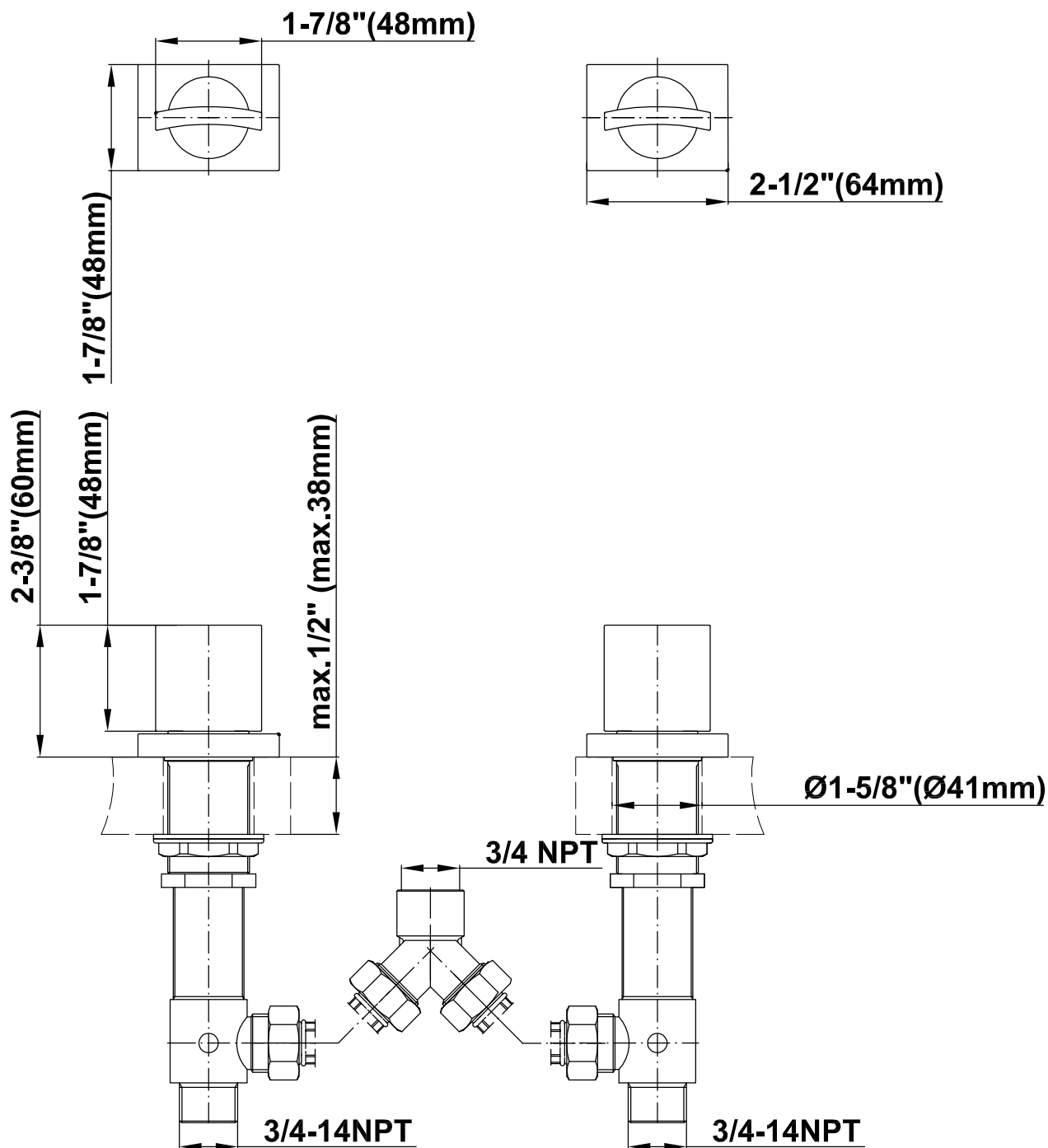

BATHROOM
Spout Connection Rough
G-1050

GRAFF®



Finishes



24K Gold



24K Brushed
Gold



Architectural
Black™



Brushed
Nickel



Matte Black



Polished
Chrome



Polished
Nickel



Stainless Steel®
(Satin Nickel)

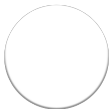

Architectural
White

G-1050

Rough

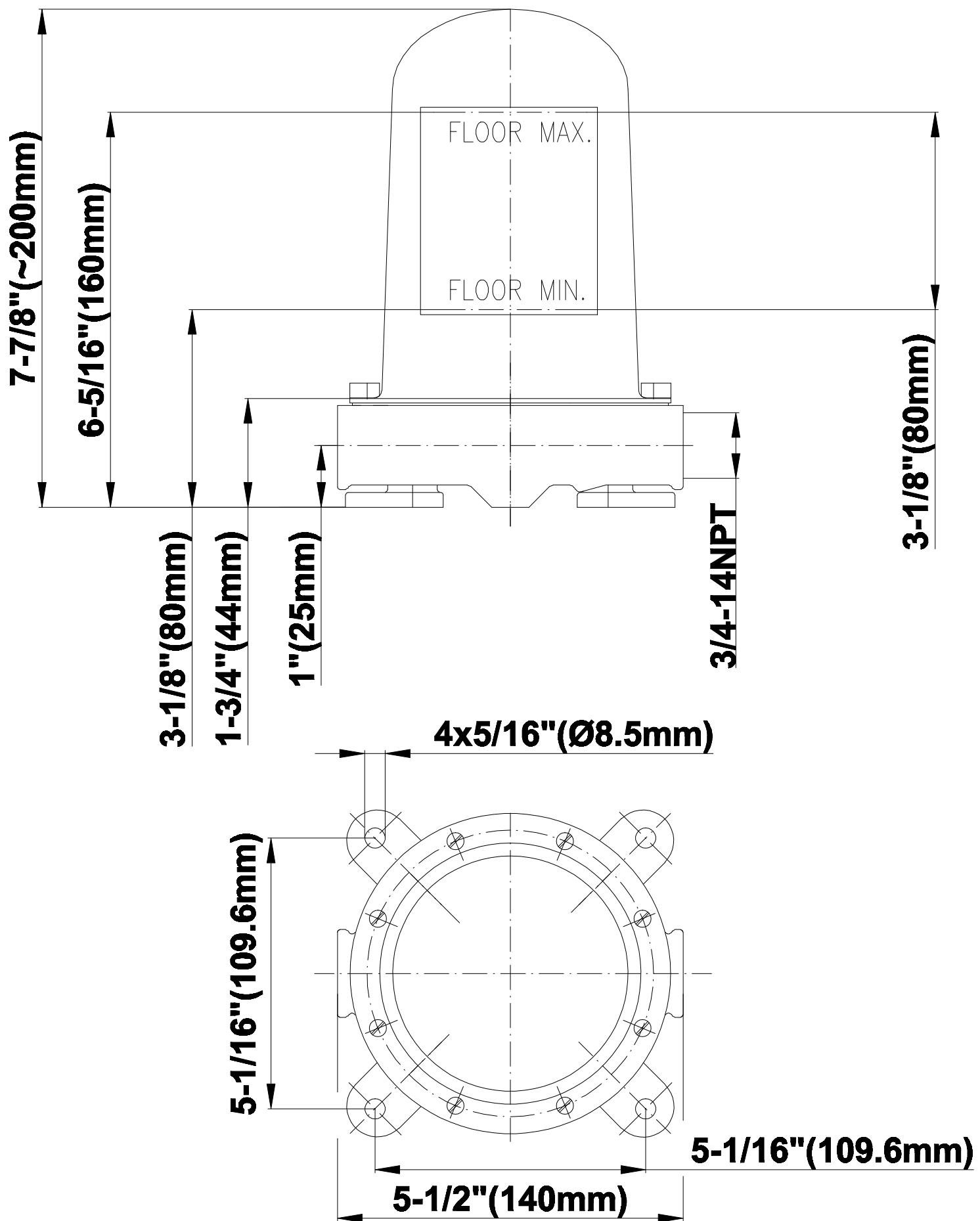

BATHROOM
Targa Floor-Mounted Tub Filler -
Spout Only
G-3652-T

GRAFF®



Information

- Floor-mount installation
- Aerated Flow Rate ~9 gpm @45 psi
- 9-7/8" spout reach
- 33-1/2" - 36-5/8" ~spout height
- Optional in-line pressure balancing valve

Finishes



24K Gold



24K Brushed
Gold



Architectural
Black™



Brushed
Nickel



Matte Black



Polished
Chrome



Polished
Nickel



Steelnox®
(Satin Nickel)

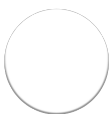

Architectural
White

G-3652

TARGA Series

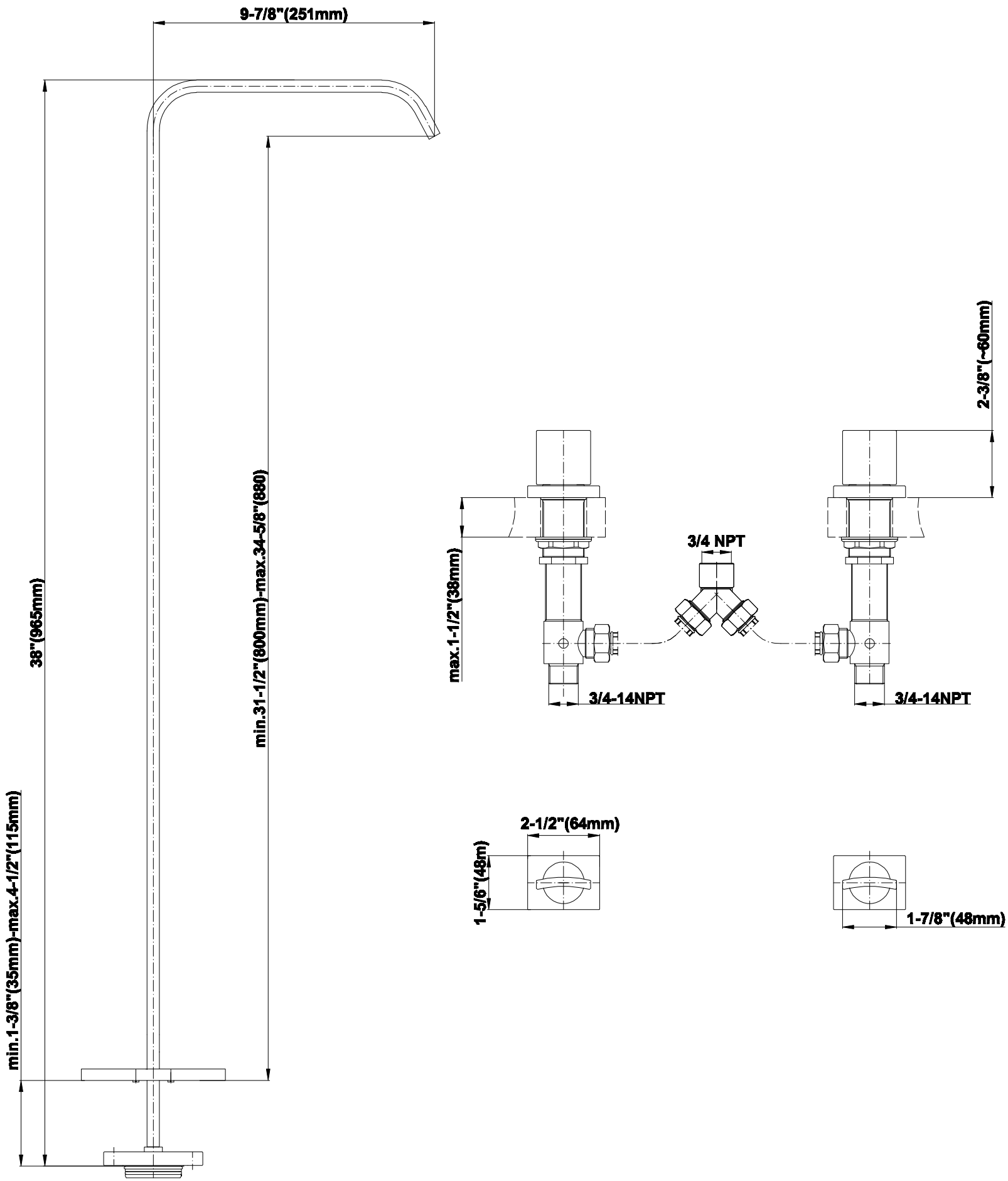

BATHROOM
Targa Deck-Mounted Handshower
& Diverter Set
G-3655

GRAFF[®]

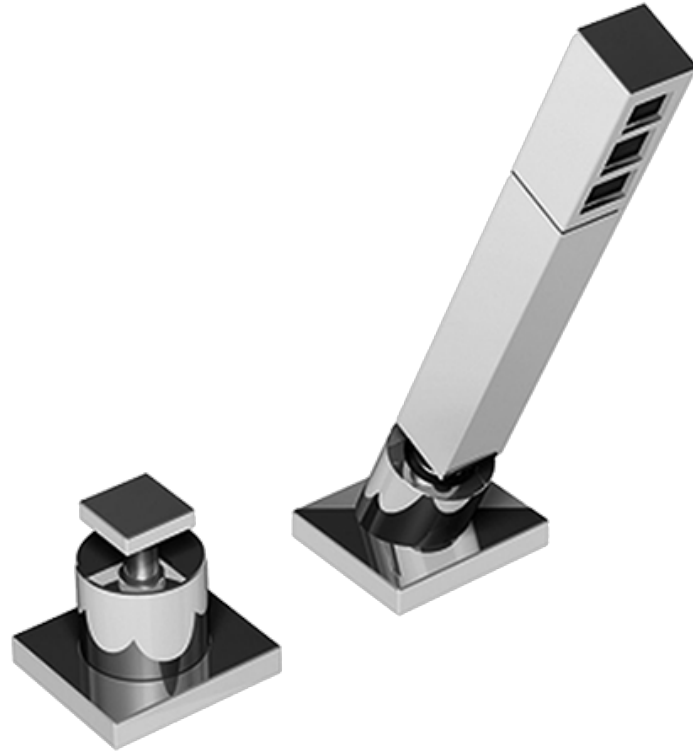

Information

- Matches G-3652-LM31 (Tub Filler)
- 1-11/32" hole cutout (x2)

Finishes



24K Gold



24K Brushed
Gold



Architectural
Black™



Brushed
Nickel



Matte Black



Polished
Chrome



Polished
Nickel



Steelnox[®]
(Satin Nickel)



Architectural
White

G-3655

TARGA Series

